



TEETER TOTTER



WowWee Group Limited.

WowWee Canada Inc.

Customer Service:

More information on:

Item no.:

Age:

Manufactured and distributed by
© 2016 WowWee Group Limited.

All Rights Reserved.

Energy Plaza, 301A-C, 92 Granville Road
T.S.T. East, Hong Kong

3700 Saint Patrick Street, Suite 206, Montreal
QC, H4E 1A2, Canada

<http://wowweezone.com>

<http://wowwee.com/fingerlings>

3745

5+

USER MANUAL

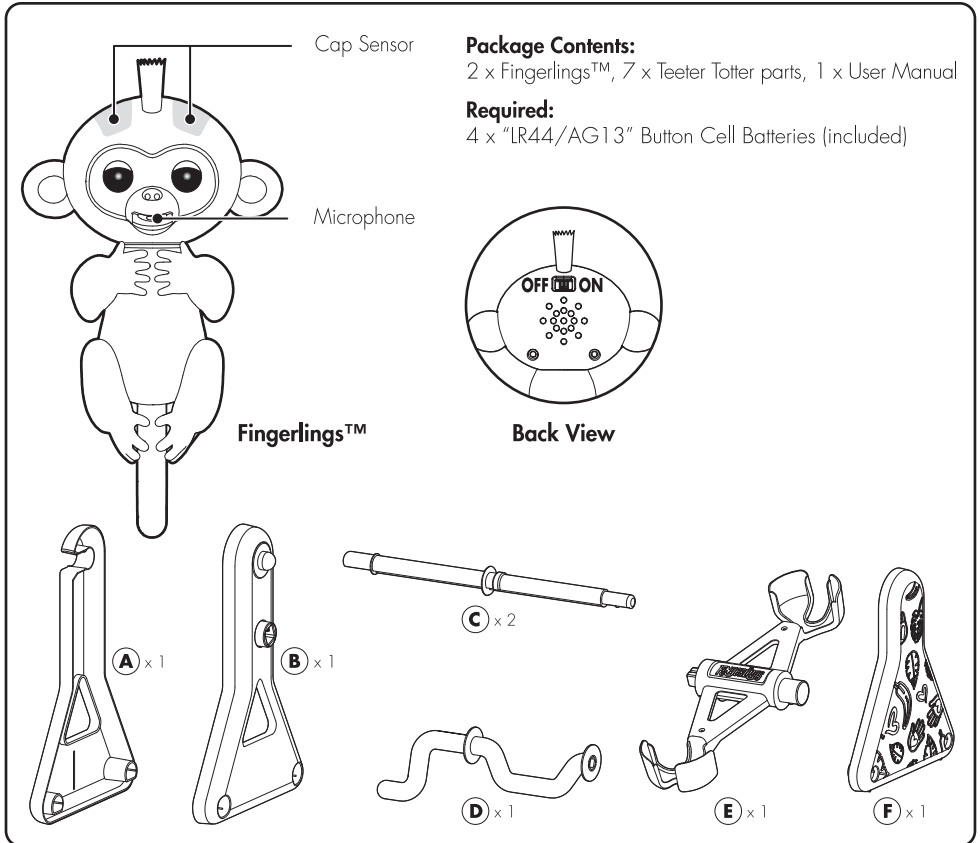

Please note the following when operating Fingerlings™:

- Do not immerse Fingerlings™ or any of its parts in water or any other form of liquid.
- Do not drop, throw, or kick Fingerlings™ as this may damage mechanical functions.
- Do not leave Fingerlings™ unattended near edges from which it could fall.
- Assembly should be supervised by Adults.

HOW TO PLAY

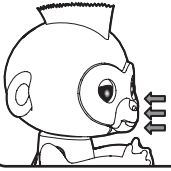

Blow air kisses to your monkey

Your monkey will kiss you back!

SLEEP MODE:

To conserve energy, your Fingerlings™ will enter sleep mode after 5 minutes of inactivity. Flip the power switch off and on again to bring your monkey back to life.

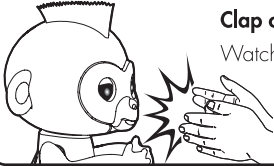

Clap once or twice

Watch it monkey around!



Pet your monkey's head

Your monkey will show you love!



Tap your monkey's head

For fun reactions!



Press & hold both sensors (2s)

For a silly surprise!

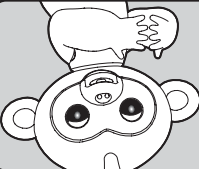

Hang your monkey upside down

Explore your monkey's silly side!



Cradle your monkey

For sleepy reactions!

BATTERY INFORMATION

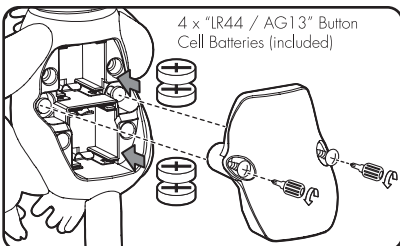

4 x "LR44 / AG13" Button Cell Batteries (included)

Fingerlings™ Battery Diagram/Installation

Installing or changing batteries in Fingerlings™:

1. Lay Fingerlings™ down so that the battery compartment faces upwards. Fingerlings™ requires 4 x "LR44 / AG13" Button Cell Batteries (included).
2. Using a Phillips screwdriver (not included) remove the screws on the battery compartment cover.
3. Remove any existing batteries and insert new batteries according to the diagram. Ensure that the positive and negative polarities match the illustrations inside the battery compartment.
4. Replace the battery compartment cover and tighten screws using the screwdriver. Do not overtighten.

LOW BATTERY INDICATORS:

When the batteries grow weak, Fingerlings™ will become slow and unresponsive. When this happens, Power OFF and replace all batteries.

ASSEMBLY INSTRUCTION

STEP 1

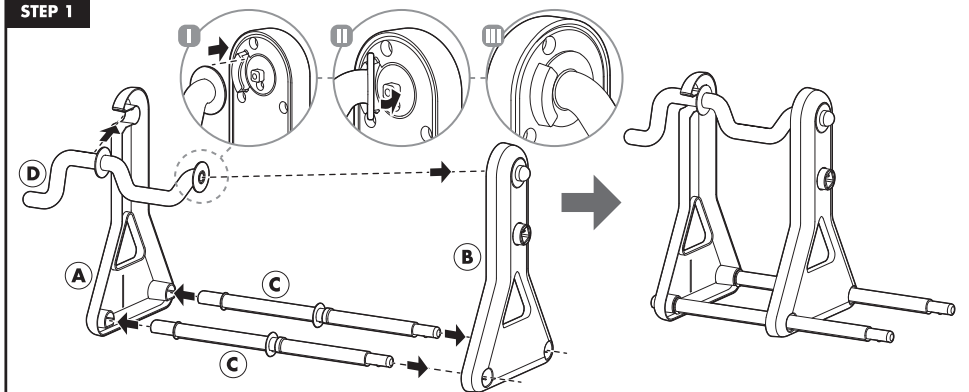

STEP 2

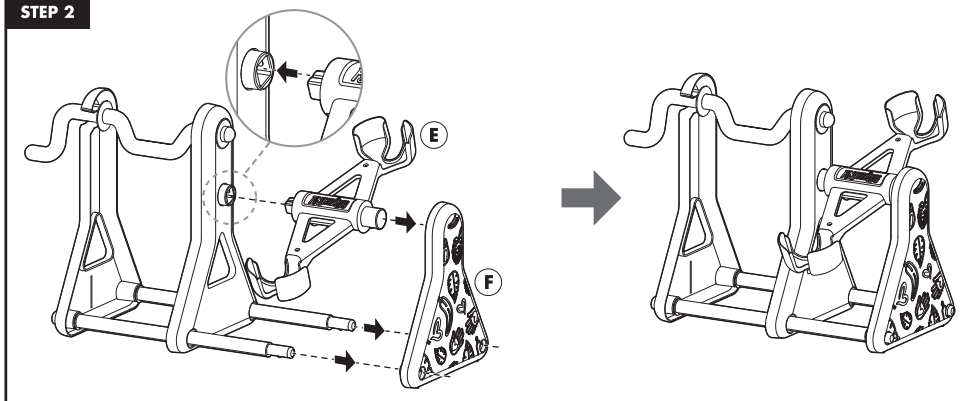

*Must be conducted by adult.

IMPORTANT BATTERY INFORMATION:

- Use only fresh batteries of the required size and recommended type.
- Do not mix old and new batteries, different types of batteries [standard (Carbon-Zinc), Alkaline or rechargeable] or rechargeable batteries of different capacities.
- Remove rechargeable batteries from the toy before recharging them.
- Rechargeable batteries are only to be charged under adult supervision.
- Please respect the correct polarity, (+) and (-).
- Do not try to recharge non-rechargeable batteries.
- Do not dispose of batteries into fire.
- Replace all batteries of the same type/brand at the same time.
- The supply terminals are not to be short-circuited.
- Remove exhausted batteries from the toy.
- Batteries should be replaced by adults.
- Batteries should be recycled or disposed of as per state and local guidelines.

Manufactured and distributed by © 2016 WowWee Group Limited. Product names, designations, and logos are trademarks or registered trademarks of WowWee Group Limited. All rights reserved.

Customer Service Website: <http://wowweezone.com>

We recommend that you retain our address for future reference.

Product and colors may vary.

Packaging printed in China.

WARNING! This product is not suitable for children under 3 years because of small parts - choking hazard.

CAN ICES-3(B)/NMB-3(B)

MADE IN CHINA

CAUTION

Changes or modifications not expressly approved by the party responsible for compliance could void the user's authority to operate the equipment.

NOTE

This equipment has been tested and found to comply with the limits for a class B digital device, pursuant to part 15 of the FCC rules. These limits are designed to provide reasonable protection against harmful interference in a residential installation. This equipment generates, uses and can radiate radio frequency energy and, if not installed and used in accordance with the instructions, may cause harmful interference to radio communications.

However, there is no guarantee that interference will not occur in a particular installation. If this equipment does cause harmful interference to radio or television reception, which can be determined by turning the equipment off and on, the user is encouraged to try and correct the interference by one or more of the following measures:

- Reorient or relocate the receiving antenna
- Increase the separation between the equipment and receiver
- Connect the equipment into an outlet on a circuit different from that to which the receiver is connected
- Consult the dealer or experienced radio/TV technician for help

This Device complies with Part 15 of the FCC Rules. Operation is subject to the following two conditions:

- (1) This device may not cause harmful interference, and
- (2) This device must accept any interference received, including interference that may cause undesired operation.

For full list of inputs, please visit <http://wowwee.com/fingerlings>

For warranty information, please visit <http://wowwee.com/information/warranty>

WARNING! This equipment may experience difficulty and/or memory loss when subjected to any electrostatic discharge, radio frequency interference, or sudden power surge/interruption. The user is encouraged to reset the equipment should any of these occur.

⚠ WARNING: This product contains a coin or button cell battery. A coin or button cell battery can cause serious internal chemical burns if swallowed.

⚠ WARNING: Swallowing may lead to serious injury in as little as 2 hours or death, due to chemical burns and potential perforation of the oesophagus. Dispose of used batteries immediately and safely. Flat batteries can still be dangerous. Keep new and used batteries away from children. If you think batteries might have been swallowed or placed inside any part of the body, seek immediate medical attention.



WowWee Group Limited
Energy Plaza, 301A-C
92 Granville Road
T.S.T. East, Hong Kong

WowWee Canada Inc.
3700 Saint Patrick Street
Suite 206
Montreal, QC, H4E 1A2, Canada



3745US01TOP_MIM